

Digital AC Servo Drive ACS806

1. Introduction

Leadshine's fully digital AC servo drive ACS806 is developed with 32-bit DSP based on advanced control algorithm. Since its input commands are PUL/DIR signals, the users can upgrade stepping drives to the ACS806 without changing control systems. The ACS806 can offer high precision, high speed and high reliability performance, and widely used in inkjet printers, engraving machines, and etc. A built-in controller can be used for testing and tuning. PC based and handheld configuration & tuning tools can meet different tuning environments or requirements.



2. Features

- | Input: 18 - 80VDC,
- | Peak Current: 18A , Continuous Current: 6 A (Max), 50 - 400 W
- | FOC-SVPWM technologies
- | PC based and handheld configuration tools
- | Electronic gear rate from 1/255 to 255
- | Self-test function with trapezoidal velocity profile
- | Support PUL/DIR and CW/CCW control signals
- | Opto-isolated, support single-ended and differential inputs
- | Encoder output
- | Following error lock range adjustable
- | Over-voltage, over-current, encoder failure protections
- | 10 latest failures self-record function
- | Small size, surface-mount technology

3. Applications

Suitable for large and medium automation machines and equipments, such as inkjet printers, engraving machines, electronics manufacturing equipments, special NC machines, pick and place devices, packing devices, and so on. Particularly adapt to the applications require high speed, high precision, and low motor noise.

4. Specifications

Electrical Specifications (T_j = 25°C/77°F)

Parameters	ACS806			
	Min.	Typical	Max.	Unit
Peak output current	0	-	18	A
Continue output current	0	-	6	A
Supply voltage	+18	-	+80	VDC
Logic signal current	7	10	16	mA
Pulse input frequency	0	-	600	kHz
Isolation resistance	500			MΩ
Current provided to encoder	-	-	100	mA

Performance Specifications (with ACM Series Servo Motors)

- | Position following error : +/-1 count
- | Velocity accuracy: +/-2rpm
- | Maximum acceleration speed (No Load) : 80 rpm/ms²
- | Input frequency up to 600 kHz
- | Maximum speed : 4000 rpm
- | Allowable low speed reaches 1 rpm
- | Positioning accuracy : +/-1 count
- | Suitable for 18 - 80 VDC AC servo motors

Operating Environment and Parameters

Cooling	Natural cooling or Forced cooling	
Operating Environment	Environment	Avoid dust, oil fog and corrosive gases
	Ambient Temperature	0°C – 50°C (32°F – 122°F)
	Humidity	40% RH – 90% RH
	Vibration	5.9m/s ² Max
Storage Temperature	-20°C – 65°C (-4°F – 149°F)	
Weight	Approx. 450g (15.88oz)	

Mechanical Specifications (unit: mm[inch])

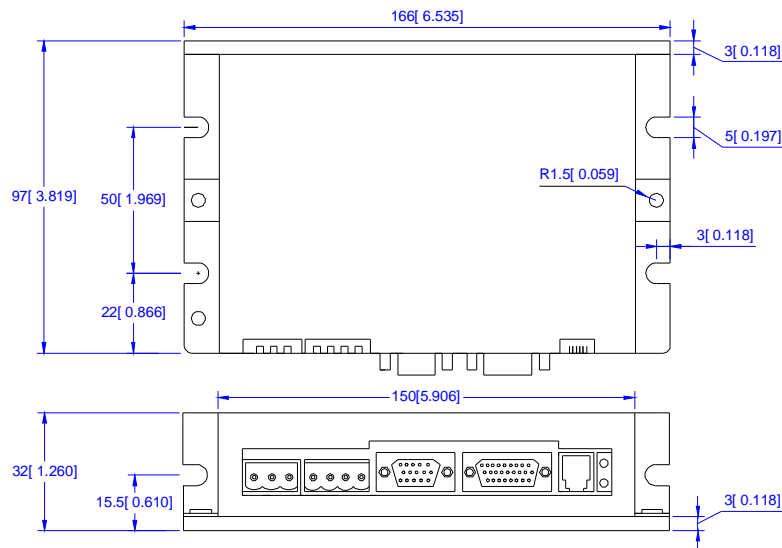

Figure 1: Mechanical specifications

5. Connector Configuration

General Information

Digital & Analog I/O Connector			
Pin	Signal	Description	I/O
1	ENA+	Enable signal input +	I
2	ENA-	Enable signal input -	I
3	PUL+	Pulse signal input +	I
4	PUL-	Pulse signal input -	I
5	DIR+	Direction signal input +	I
6	DIR-	Direction signal input -	I
7	FL	Positive limit signal input	I
8	RL	Negative limit signal input	I
9	SGND	Signal ground	GND
10	Pend+	In position signal output+	O
11	Pend-	In position signal output-	O
12	ALM+	Alarm output signal+	O
13	ALM-	Alarm output signal-	O
14	NC	Not connected	-
15	NC	Not connected	-
16	NC	Not connected	-
17	FG	Ground terminal for shield	GND
18	SGND	Signal ground	GND
19	+5V	+5V@10mA power supply	O
20	A+	Encoder channel A+ output	O
21	A-	Encoder channel A- output	O
22	B+	Encoder channel B+ output	O
23	B-	Encoder channel B- output	O

24	Z+	Encoder channel Z+ output	O
25	Z-	Encoder channel Z- output	O
26	SGND	Signal ground	GND

Halls & Encoder Connector

Pin	Signal	Description	I/O
1	EA+	Encoder channel A+ input	I
2	EB+	Encoder channel B+ input	I
3	EGND	Signal ground	GND
4	HallW+	Hall sensor W+ input	I
5	HallU+	Hall sensor U+ input	I
6	FG	Ground terminal for shielded	GND
7	EZ+	Encoder channel Z+ input	I
8	EZ-	Encoder channel Z- input	I
9	HallV+	Hall sensor V+ input	I
10	HallV-	Hall sensor V- input	I
11	EA-	Encoder channel A- input	I
12	EB-	Encoder channel B- input	I
13	VCC	+5V @ 100 mA max.	O
14	HallW-	Hall sensor W- input	I
15	HallU-	Hall sensor U- input	I

High Voltage Connector

Pin	Signal	Description	I/O
1	PE	Motor case ground	GND
2	U	Motor phase U	O
3	V	Motor phase V	O
4	W	Motor phase W	O
5	Rbrake	Brake resistor connection (VDC-RBrake)	I
6	+Vdc	DC power Input (18-80VDC)	I
7	GND	Power Ground.	GND

RS232 Communication Connector

Pin	Signal	Description	I/O
1	NC	Not connected	-
2	+5V	+5V power only for STU.	O
3	TxD	RS232 transmit.	O
4	GND	Ground.	GND
5	RxD	RS232 receive.	I
6	NC	Not connected	-

More about I/O Signals

Signal	Description
ENA+/ENA-	Enable input signal. This signal used for enabling/disabling the drive. High level for enabling the drive and low level for disabling the drive. Usually left UNCONNECTED (ENABLED) .
PUL+/PUL-	Pulse input signal. In single pulse (pulse/direction) mode, this input represents pulse signal, each rising or falling edge active (software configurable); 4-5V when PUL-HIGH, 0-0.5V when PUL-LOW. In double pulse mode (pulse/pulse) , this input represents clockwise (CW) pulse, active at both high level and low level . For reliable response, pulse width should be longer than 0.85μs. Series connect resistors for current-limiting when +12V or +24V used. The same as DIR and ENA signals.
DIR+/DIR-	Directions input signal. In single-pulse mode, this signal has low/high voltage levels, representing two directions of motor rotation; in double-pulse mode (software configurable), this signal is counter-clock (CCW) pulse, active at both high level and low level. For reliable motion response, DIR signal should be ahead of PUL signal by 5μs at least. 4-5V when DIR-HIGH, 0-0.5V when DIR-LOW.
FL/RL	Positive or negative limit input signal. Use signal ground for reference. 0-0.5V is Low level input and 4-5V is High Level input. The active level can be set with configuration tools such as ProTuner, STU-ACS. If active at low level, FL/RL must be kept at high level for normal drive operation, and the drive will short-circuit the motor coils to stop the motor immediately when FL/RL turn to low level. If active at high level, FL/RL must be kept at low level for normal drive operation, and the drive will short-circuit the motor coils to stop the motor immediately when FL /RL turn to high level. Please select active at high level when RL/RL is not connected.

More about I/O Signals(Continue)

Pend+/Pend-	In position signal output. OC output, high impedance when the position error is more than 2 pulses and low impedance when the position error is less than 2 pluses.
ALM+/ALM-	Alarm signal output. OC output, high impedance when the working status is normal and low impedance when over-voltage, over-current, phase error, encoder error, limit error, position following error happens.
A+/A-/B+/B-/Z+/Z-	Encoder feedback signals output, usually offered to the controller for external velocity/position loop.

6. RS232 Interface Connection

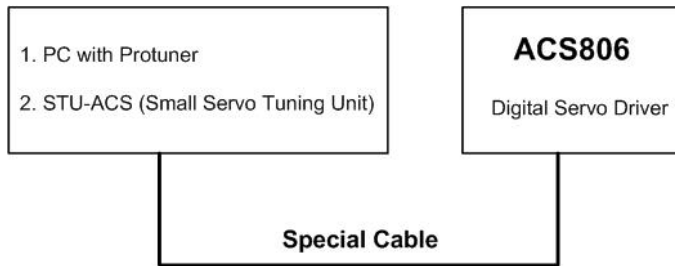

Figure 2: RS232 interface connection

7. Typical Connections

A typical connection of the ACS806 is shown as Figure 3.

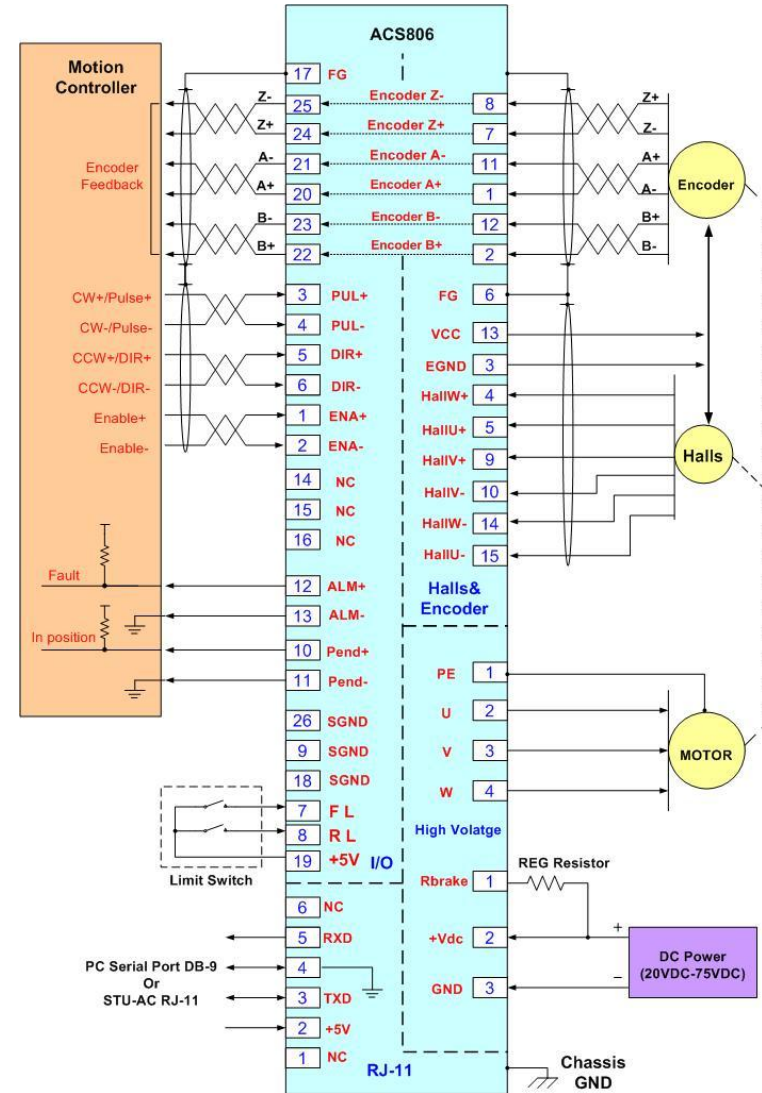

Figure 3: Typical connection of ACS806

8. Accessories

ACS806 Accessories and Connections

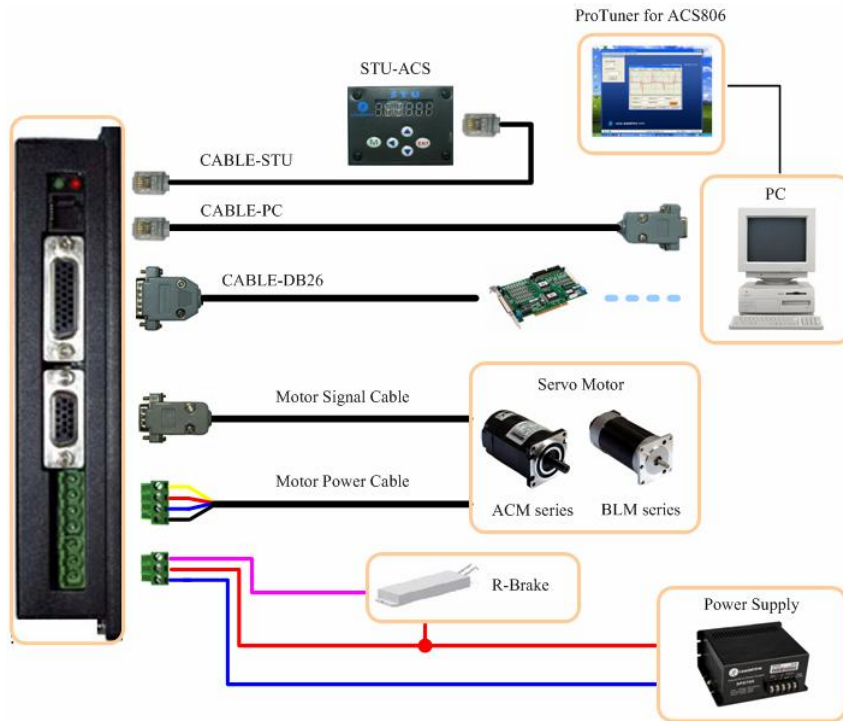

Figure 4: ACS806 accessories and connections

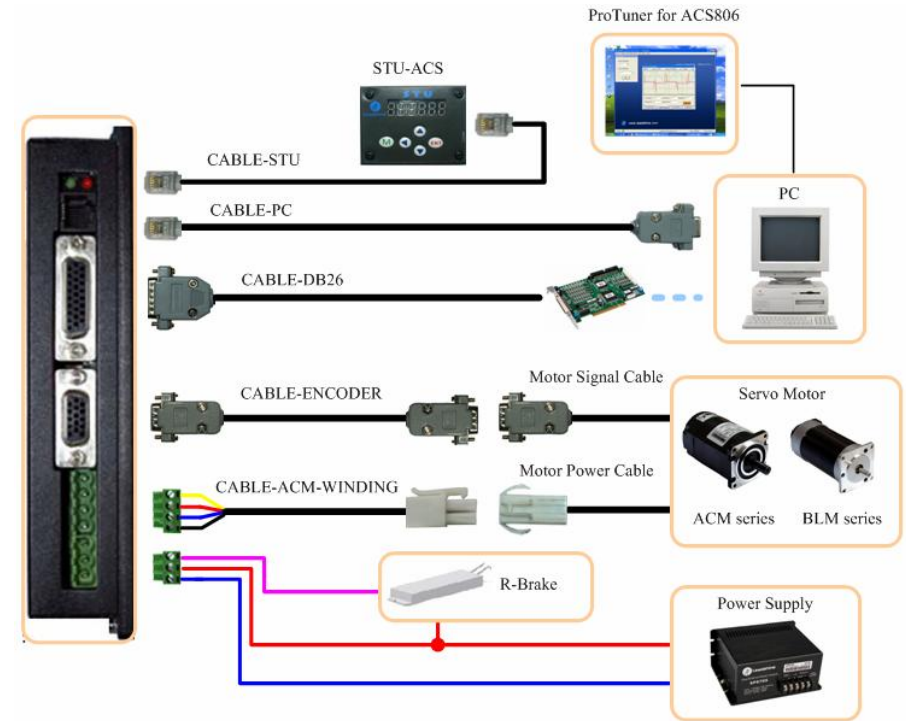



Figure 5: ACS806 accessories and connections with extended cables

More Information about ACS806 Accessories

ProTuner	
Description	PC-based configuration & tuning software.
Order	Standard Accessory, user can download from Leadshine website for free.
	

CABLE-PC

Description	Special RS232 cable designed to setup communication between the drive and PC-based configuration & tuning software ProTuner .
Order	Standard Accessory, one is enough for a user to configure and tune multiple drives.

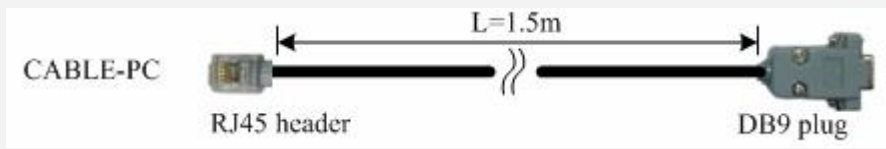

STU-ACS

Description	Handheld configuration & tuning unit.
Order	Optional Accessory, one is enough to configure and tune multiple drives.



CABLE-STU

Description	Special RS232 cable designed to setup communication between drive and Handheld configuration & tuning unit STU-ACS .
Order	One STU-ACS needs at least one.

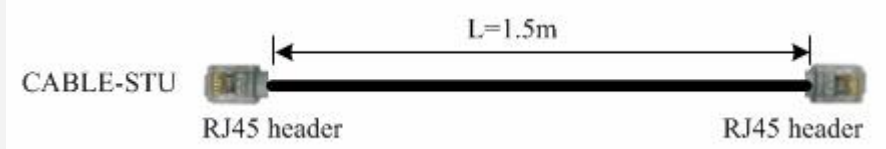

CABLE-DB26

Description	Connector and cable for control signals include ENA+, ENA-, PUL+, PUL-, DIR+ and DIR-.
Order	Standard Accessory, one driver needs at least one.



	Pin	Color	Signal	Description
Wires	1	Green	ENA+	Enable signal input +
	2	Black	ENA-	Enable signal input -
	3	Red	PUL+	Pulse signal input +
	4	Yellow	PUL-	Pulse signal input -
	5	Blue	DIR+	Direction signal input +
	6	White	DIR-	Direction signal input -
	17	-	FG	Ground terminal for shielded

CABLE-ACM-ENCODER

Description	Extended cable for the feedback wires between the driver and servo motor.
Order	Optional Accessory, Leadshine provides 1.2m, 2.2m, 5m, 10m cable for user selection. Users can select the proper length according to their needs.

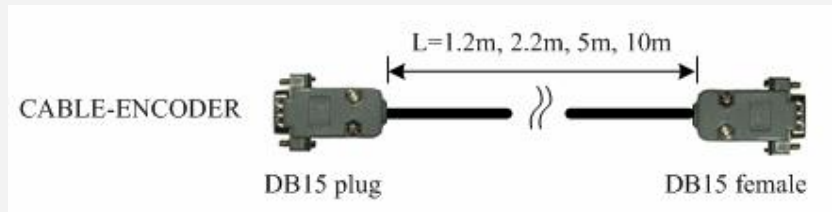

CABLE-ALM-WINDING

Description	Extended cable for power leads between the drive and Leadshine ACM series AC servo motor.
Order	Optional Accessory, Leadshine provides 1.2m, 2.2m, 5m, 10m cable for user selection. Users can select the proper length according to their needs.

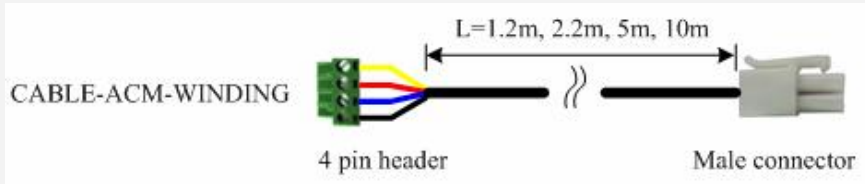

Wires	Pin	Color	Signal	Description
	1	Yellow	PE	Motor case ground
	2	Red	U	Motor phase U
	3	Blue	V	Motor phase V
	4	Black	W	Motor phase W